

REV.	Description	Date
1	upgrade drawing	2015/6/15

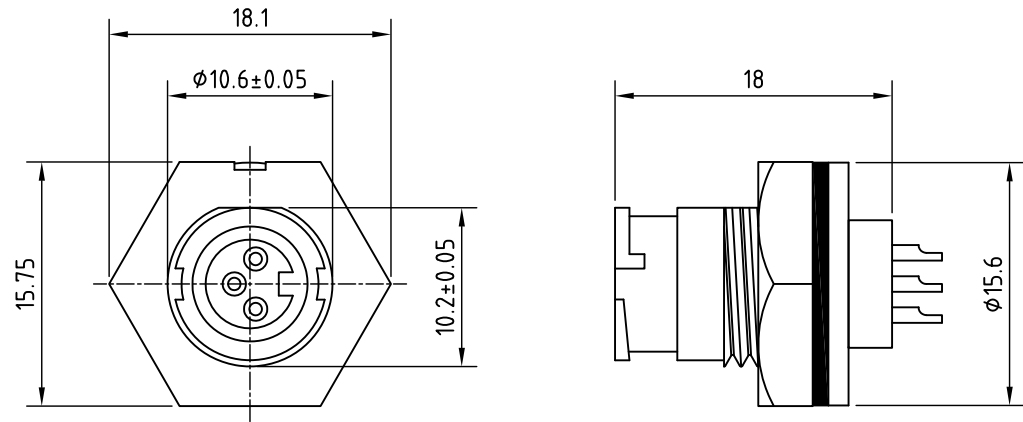

Specification of connector

- General Characteristics
- Locking system : snap-in
 - Termination : solder
 - Shell protection : IP67
 - Contact resistance : $\leq 10\text{m}\Omega$
 - Insulation resistance : $\geq 10\text{M}\Omega$

RoHS
TOLERANCE X±0.5 X.X±0.3

CONTACT ARRANGEMENT FRONT VIEW (FEMALE)		
	2P	3P
Rated voltage	250V	
Rated current	5A	

4	Nut	PA	
3	O ring	Rubber	
2	Body	PA	
1	Pin	Brass	Gold plated
Item	Description	Material	Treat & Remark



Unicable Co., Ltd. 國陽電業有限公司
5F., No. 111-33, Sec. 4, San Ho Road, San Chung City, Taiwan, R.O.C.
<http://www.unicable.com.tw> TEL:+886-2-2286-2122 FAX:+886-2-2286-1010

DATE	2016/10/7	PART NO.	UT-SP207M1-XP
DWN	GINA	REV.	1
CHK			
UNIT	MM		

ITEM	CIRCULAR CONNECTOR TYPE A
------	---------------------------